

Mirror Mounts



We, Radiant Dyes Laser Accessories GmbH, produce high-quality opto-mechanical components in our own manufacturing centre. The screws are made in single-part production and are aligned to the nuts. This guarantees that the screws do not scratch or bounce and they can turn smoothly without jerking.

We offer a wide range of front plates for the various mirror mounts from closed up to two inch, and for special applications for optics up to six inch.

Due to the fact that we produce everything in our own factory, we are able to manufacture also custom-made products.

Our high-quality and stable opto-mechanical components will help you to build up successful experiments.

Mirror Mounts

Options for all Mirror Mounts

Colors

All Mirror Mounts are available in four colors to signalize different optical beams :

Red
Black
Gold
Silver

The standard color is red.



Operational Safety

For optimal operational safety all opto-mechanical components are also available with a sandblasted surface.

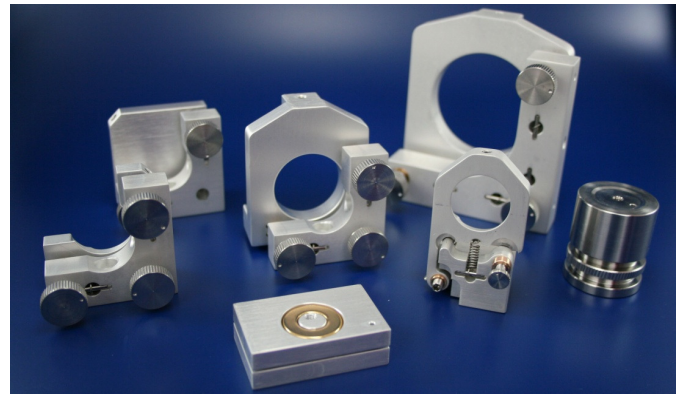

MIKRO

These mirror holders are manufactured of a special steel. They allow the assembly of a rigid resonator in a very small housing.

MRO-UL

Front plate 20 x 15 mm

MRO-ST-TR

- Beam splitter and trans adjustment
- Front plate 20 x 15 mm
- With 10 mm notch

Other versions on request.

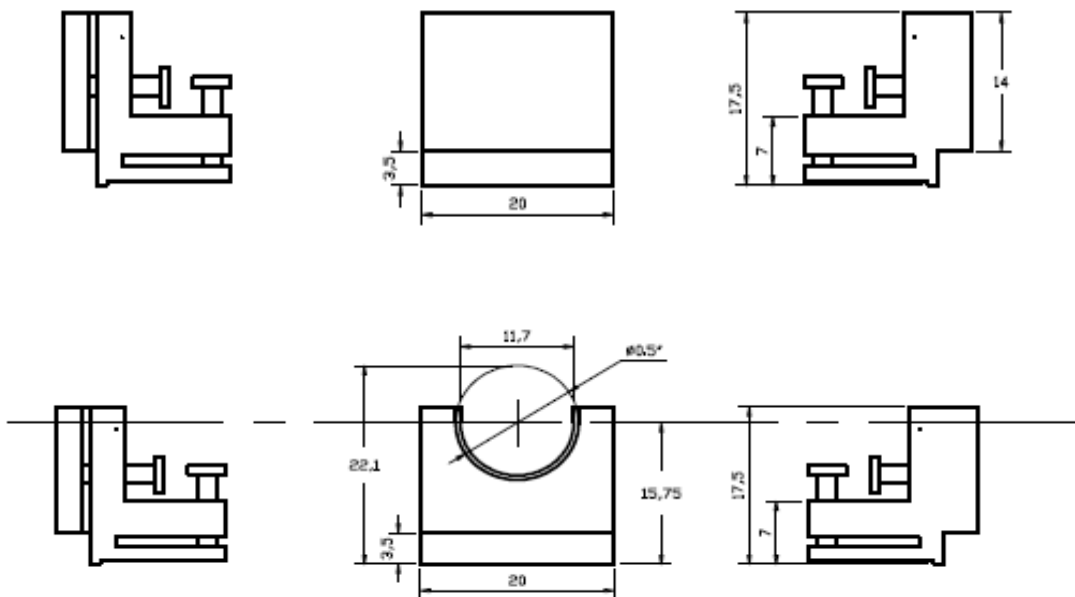
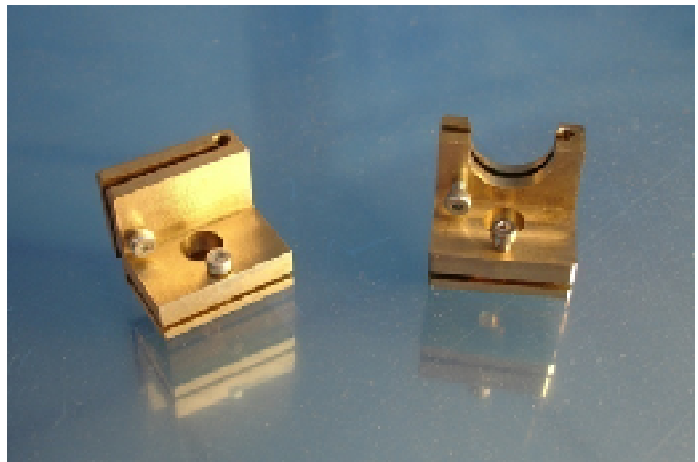

Mirror Mounts

MNI



The MNI mount is a very compact mirror mount which is ideal for application with low space. It can be used for optics up to one inch.

Features:



- Small stable Mirror Mount
- Open or closed body plate
- Different front-plates available
- M4 thread

Screw Options

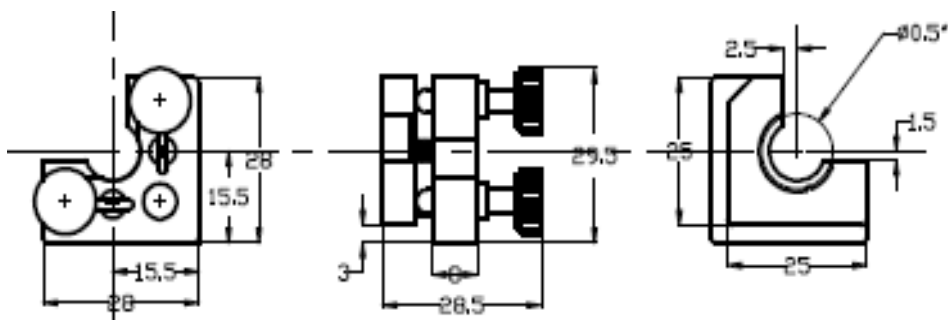
- Fine thread screws Model 1:
 - with 250 $\mu\text{m}/\text{turn}$
 - with 150 $\mu\text{m}/\text{turn}$
- Micrometer screws:
 - with 500 $\mu\text{m}/\text{turn}$
 - with 250 $\mu\text{m}/\text{turn}$
 - with 100 $\mu\text{m}/\text{turn}$

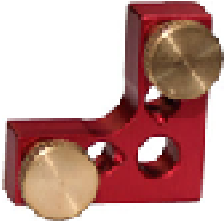
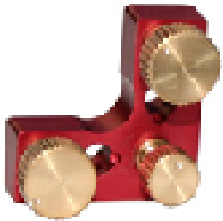

Bodies

			
MNI-2-...	MNI-3-...	MNI-2G-...	MNI-3G...

Frontplates

				
...-3000	...-3010 (6H7)	...-3021 (1/2")	...-3030 (1/2")	...-3025 (1")
				
...-3035Up	...-3035Down	NEW: Prism Holder ...-3030PH		

The order number of the desired MNI mirror mount consists of the number of the body-plate including the quantity of the screws and the number of the chosen front-plate.

Mirror Mounts

MNI-H



The MNI-H is the high stable version of the MNI mirror mount. The MNI-H can be used for applications where a high stability is necessary.

Features:

- Small high stable Mirror Mount
- 4 springs
- Open or closed body plate
- Different front-plates available
- Stainless steel insert for stabilisation
- M4 thread

Screw Options

- Fine thread screws Model 1:
 - with 250 $\mu\text{m}/\text{turn}$
 - with 150 $\mu\text{m}/\text{turn}$

- Micrometer screws:

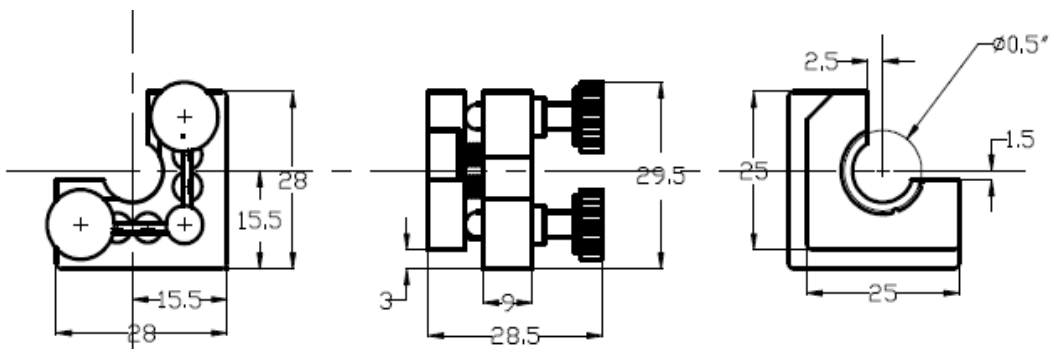

NEW: with 500 $\mu\text{m}/\text{turn}$
with 250 $\mu\text{m}/\text{turn}$
with 100 $\mu\text{m}/\text{turn}$



Bodies

		<p><i>Due to strong spring forces we offer the MNI-H only with two alignment screws. If a third screw should be necessary, we recommend the screw as hexagon socket for easier alignment</i></p>
MNI-H-2-...	MNI-H-2G-...	

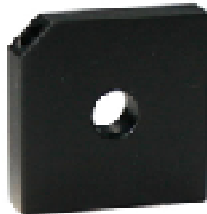
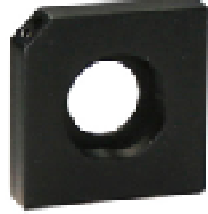
Frontplates

				
...-3000	...-3010 (6H7)	...-3021 (1/2")	...-3030 (1/2")	...-3025 (1")

	
...-3035Up	...-3035Down

The order number of the desired MNI-H mirror holder consists of the number of the body-plate including quantity of the screws and the number of the chosen front-plate.

MNI-H-U

- Extra small Mirror Mount
- 4 strong springs
- High-precision screws with hexagon socket
- Option: with locking device

MNI-H-U-2-3030
MNI-H-U-3-3030



Mirror Mounts

MDI



The MDI is our most popular mirror mount. The mount is available with different front plates (from closed up to two inch) and two or three screws. It is our standard mirror mount which can be used for most applications in the lab.

Features:



- Stable Mirror Mount
- Open or closed body plate
- Different front-plates available
- M6 thread with M4 inner lower-ring (standard)
- M4 or M8 thread available on request

Screw Options:

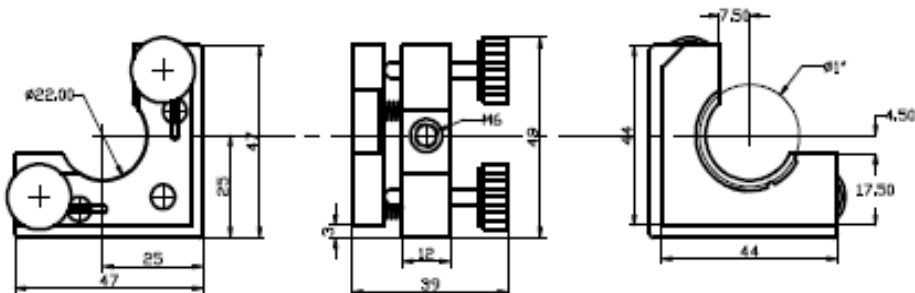



- Fine thread screws Model 3:
 - with 250 $\mu\text{m}/\text{turn}$
 - with 150 $\mu\text{m}/\text{turn}$
- Micrometer screws:
 - with 500 $\mu\text{m}/\text{turn}$
 - with 250 $\mu\text{m}/\text{turn}$
 - with 100 $\mu\text{m}/\text{turn}$





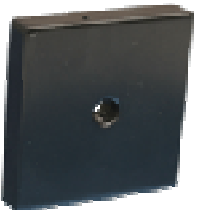







Bodies

			
MDI-2-...	MDI-3-...	MDI-2G-...	MDI-3G...

Frontplates

				
...-3000	...-3010 (6H7)	...-3021 (1/2")	...-3025 (1")	...-3030z (1")

				
...-3030 (1")	...-3060 (1")	...-3000-25 (1")	...-3040 (1,5") ...-3045 (2")	...-3050 (1,5") ...-3055 (2")

				
...-3035Up	...-3035Down	...-3000-27 for Optics 27x50 mm	...-3030PH Prism Holder	...-3030H (1")

The order number of the desired MDI mirror mount consists of the number of the body-plate including quantity of the screws and the number of the chosen front-plate.

Mirror Mounts

MDI-HS



The MDI-HS is the high stable version of the MDI mirror mount. The MDI-HS can be used for applications where a high stability is necessary.

Features:

- High-stable Mirror Mount
- 4 springs
- Stainless steel insert for stabilisation
- Thicker open body plate
- Different front-plates available
- M6 thread with M4 inner lowering (standard)
- M4 thread available on request

Screw Options:

- Fine thread screws Model 4:
 - with 250 $\mu\text{m}/\text{turn}$
 - with 150 $\mu\text{m}/\text{turn}$
 - Micrometer screws:
 - with 500 $\mu\text{m}/\text{turn}$
 - with 250 $\mu\text{m}/\text{turn}$
 - with 100 $\mu\text{m}/\text{turn}$
- NEW:**

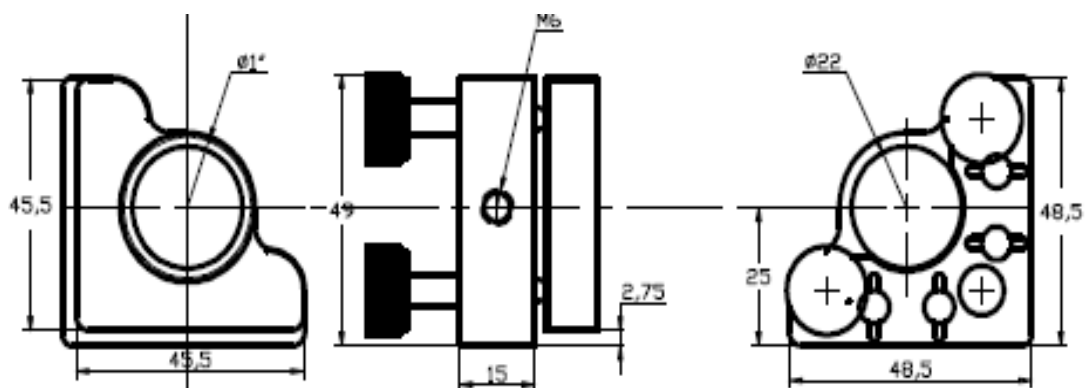

Bodies



Due to strong spring forces we offer the MDI-HS only with two alignment screws. If a third screw should be necessary, we recommend the screw as hexagon socket for easier alignment

MDI-HS-2...

Frontplates

...-3000	...-3010 (6H7)	...-3021 (1/2")	...-3025 (1")	...-3030z (1")
...-3030 (1")	...-3060 (1")	...-3000-25 (1")	...-3040 (1,5") ...-3045 (2")	...-3050 (1,5") ...-3055 (2")
...-3035Up	...-3035Down	...-3000-27 for Optics 27x50 mm	...-3030H (1")	

The order number of the desired MDI-HS mirror mount consists of the number of the body-plate including quantity of the screws and the number of the chosen front-plate.

MDI-H



The MDI-H is the most stable mirror mount in our product range. The optics are fixed by a retaining ring instead of a set screw.

Features:

- High-stable Mirror Mount
- Standard MDI-H with axial mounting ring for distortion free wavefront
- 4 springs
- Stainless steel insert for stabilisation
- Thicker open body plate
- Thicker front plates
- Different front-plates available
- M6 thread with M4 inner lowering (standard)
- M4 thread available on request

Screw Options:

- Fine thread screws Model 4:
 - with **250** $\mu\text{m}/\text{turn}$
 - with **150** $\mu\text{m}/\text{turn}$
- Micrometer screws:
 - with **500** $\mu\text{m}/\text{turn}$
 - with **250** $\mu\text{m}/\text{turn}$
 - NEW:** with **100** $\mu\text{m}/\text{turn}$

MDI-HC Ceramic

As special option we offer the MDI-HC. This is a high-stable mirror mount made of ceramic. We offer this mirror mount with stainless steel screws or brass screws, this is up to the customers wishes.

This mirror mount guarantees the highest stability.



Bodies

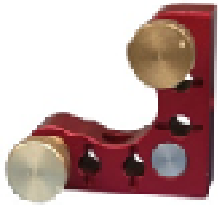

Due to strong spring forces we offer the MDI-H only with two alignment screws. If a third screw should be necessary, we recommend the screw as hexagon socket for easier alignment

MDI-H-2...

Frontplates

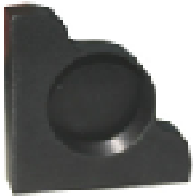

...-3010
(1")

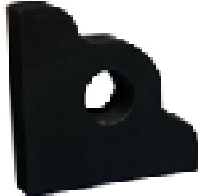

...-3021
(1/2")

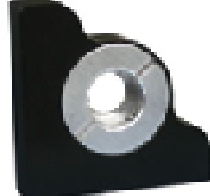

...-E3021
(1/2")



...-3025
(1")

Easy MDI



E-MDI-2-3031

The Easy MDI is a low cost version of the MDI mirror mount. But the Easy MDI also guarantees a precise and repeatable adjustment for one inch optics.

Features:

- Precisely adjustable
- Low price

The difference to the original MDI:

- shorter adjusting range
- with smaller screw head
- no carbide spikes
- without thread but with lowering for M4 screws
- only available with 2 screws

Mirror Mounts

MXI



The MXI mirror mount is our standard mount for two inch optics. Due four strong springs this mount is high stable.

Features:

- High Stable Mirror Mount
- 4 springs
- Thicker body plate
- Different front-plates available
- M6 thread with M4 inner lowering (standard)
- M4 thread available on request

Screw Options:

- Fine thread screws Model 5:
with **250** $\mu\text{m}/\text{turn}$
with **150** $\mu\text{m}/\text{turn}$



- Micrometer screws:

with **500** $\mu\text{m}/\text{turn}$
with **250** $\mu\text{m}/\text{turn}$
with **100** $\mu\text{m}/\text{turn}$

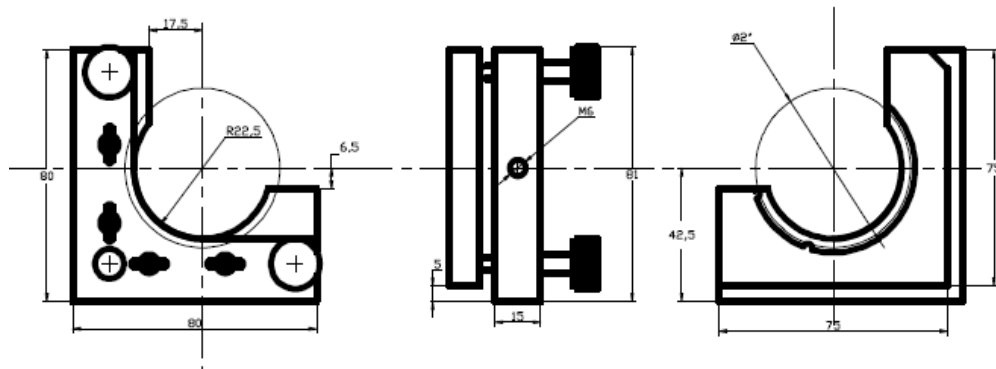



NEW:

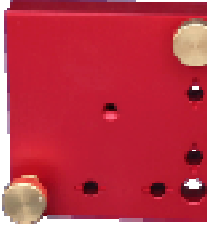
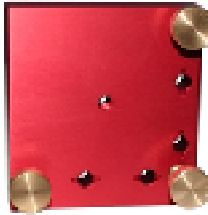

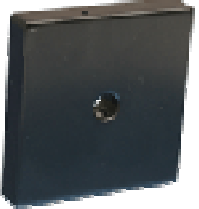

Bodies

			
MXI-2-...	MXI-3-...	MXI-2G-...	MXI-3G-...

Frontplates

				
...-3000	...-3010 (6H7)	...-3021 (1/2")	...-3025 (1") ...-3027 (2")	...-3030 (2")

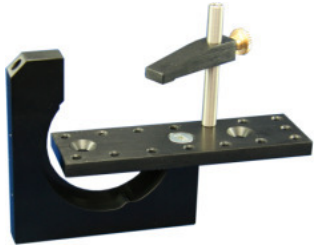
		
...-3030z (2")	-3050 (1,5")	NEW: Prism Holder ...-3030PH

The order number of the desired MXI mirror mount consists of the number of the body-plate including quantity of the screws and the number of the chosen front-plate.

Mirror Mounts

RD1



The RD1 is a small stable mirror mount with an integrated base.

Features:



- Very Stable Mirror Mount
- Available in “right hand” and “left hand”
- Different front-plates available
- With M8, M6 or M4 thread

Screw Options:

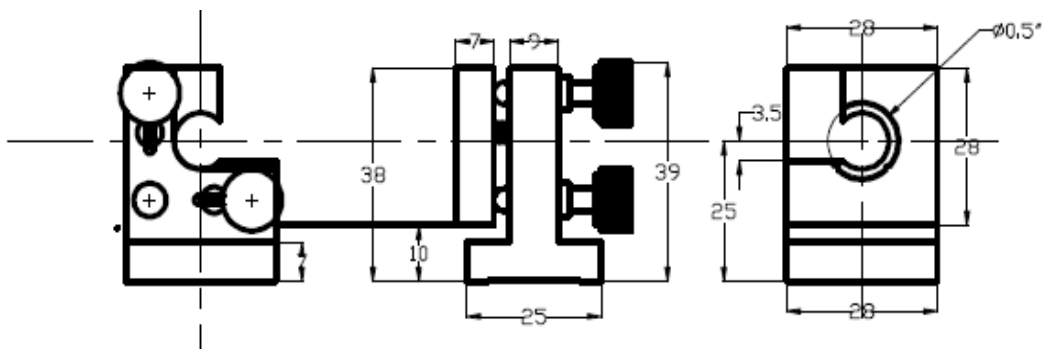

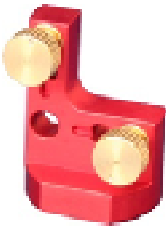
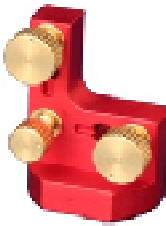
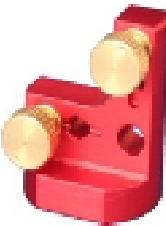

- Fine thread screws Model 2:
 - with 250 $\mu\text{m}/\text{turn}$
 - with 150 $\mu\text{m}/\text{turn}$
- Micrometer screws:
 - with 500 $\mu\text{m}/\text{turn}$
 - with 250 $\mu\text{m}/\text{turn}$
 - with 100 $\mu\text{m}/\text{turn}$



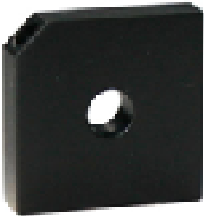

Bodies

			
RD1-L2-30...	RD1-L3-30...	RD1-R2-40...	RD1-R3-40...

Frontplates

				
...-3000/4000	...-3010/4010 (6H7)	...-3021/4021 (0,5'')	...-3030/4030 (0,5'')	...- 3025/4025 (1'')

	
...-3035Up ...-4035Up	...-3035Down ...-4035Down

The order number of the desired RD1 mirror mount consists of the number of the body-plate including quantity of the screws and the number of the chosen front-plate.

RD1-HS



The RD1-HS is the high stable version of the RD1 mirror mount. The RD1-HS can be used for applications where a high stability is necessary.

Features:

- High Stable Mirror Mount
- Available as “right hand” and “left hand” version
- 4 springs
- Stainless steel insert for stabilisation
- Different front-plates available
- With M8, M6 or M4 thread

Screw Options :



- Fine thread screws Model 2:
 - with 250 $\mu\text{m}/\text{turn}$
 - with 150 $\mu\text{m}/\text{turn}$
- Micrometer screws:
 - with 500 $\mu\text{m}/\text{turn}$
 - with 250 $\mu\text{m}/\text{turn}$
 - with 100 $\mu\text{m}/\text{turn}$



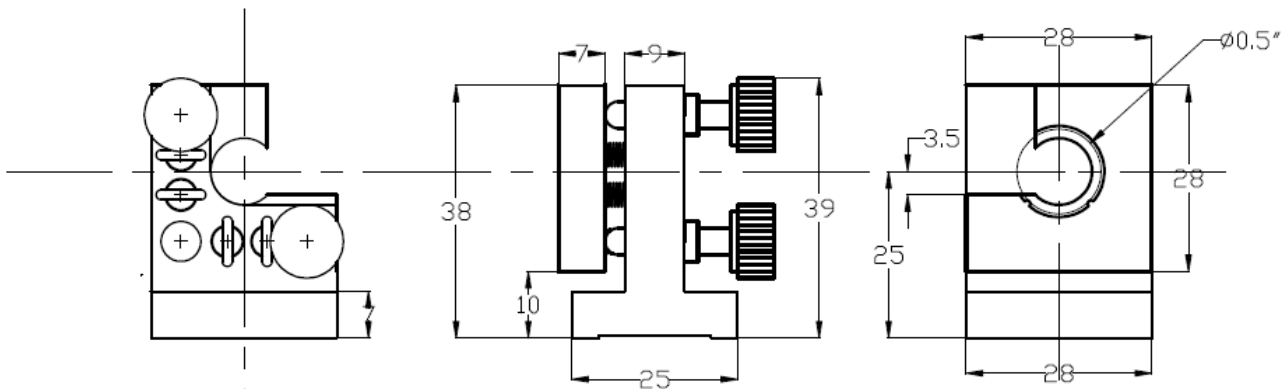

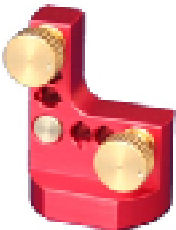

NEW:

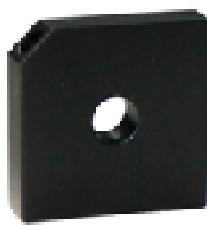

Bodies

		<p><i>Due to strong spring forces we offer the RD1-HS only with two alignment screws. If a third screw should be necessary we recommend the screw as hexagon socket for easier alignment</i></p>
RD1-HS-L2-30...	RD1-HS-R2-40...	

Frontplates

				
...-3000/4000	...-3010/4010 (6H7)	...-3021/4021 (0,5“)	...-3030/4030 (0,5“)	...- 3025/4025 (1“)

	
...-3035Up ...-4035Up	...-3035Down ...-4035Down

The order number of the desired RD1-HS mirror mount consists of the number of the body-plate including quantity of the screws and the number of the chosen front-plate.

Mirror Mounts

RD2



The RD2 is a stable mirror mount with an integrated base. It can be used for optics up to two inch.

Features:

- Very Stable Mirror Mount
- Available as “right hand” and “left hand” version.
- Different front-plates available
- With M6 or M8 thread



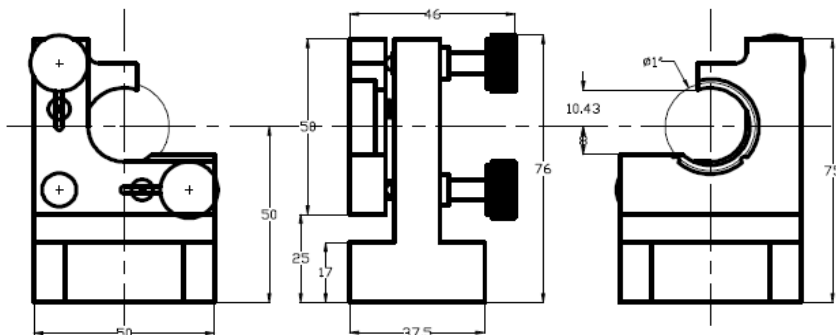

Screw Options:

- Fine thread screws Model 5:
 - with 250 $\mu\text{m}/\text{turn}$
 - with 150 $\mu\text{m}/\text{turn}$
- Micrometer screws:
 - with 500 $\mu\text{m}/\text{turn}$
 - with 250 $\mu\text{m}/\text{turn}$
 - with 100 $\mu\text{m}/\text{turn}$





NEW:







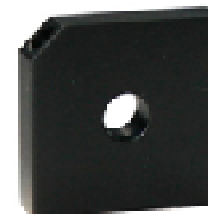

Bodies

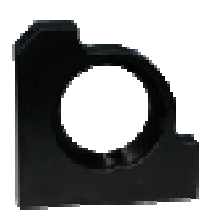
			
RD2-L2-30...	RD2-L3-30...	RD2-R2-40...	RD2-R3-40...

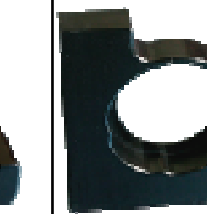
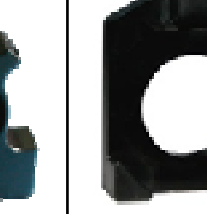
Frontplates

				
...3000/4000	...3010/4010 (6H7)	...3021/4021 (1/2")	...3025/4025 (1")	...3030/4030 (1")

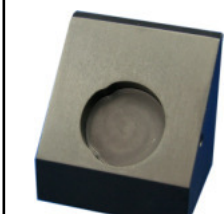
				
3030z/4030z (1")	...-3000-25(1") ...-4000-25 (1")	...-3040/4040 (1,5") ...-3045/4045 (2")	...-3060/4060 (1")	...-3050/4050 (1,5") ...-3055/4055 (2")

			
...-3035Up ...-4035Up	...-3035Down ...-4035Down	...-U(p) (1")	...-D(own) (1")

The order number of the desired RD2 mirror mount consists of the number of the body-plate including quantity of the screws and the number of the chosen front-plate.

RD2-HS



The RD2-HS is the high stable version of the RD2 mirror mount. The RD2-HS can be used for applications where a high stability is necessary.

Features:

- High-stable Mirror Mount
- Available as “right hand” and “left hand” version
- 4 springs
- Stainless steel insert for
- Stabilisation
- Different front-plates available
- With M6 or M8 thread

Screw Options :

- Fine thread screws Model 5:
 - with **250** $\mu\text{m}/\text{turn}$
 - with **150** $\mu\text{m}/\text{turn}$
- Micrometer screws :
 - with **500** $\mu\text{m}/\text{turn}$
 - with **250** $\mu\text{m}/\text{turn}$
 - with **100** $\mu\text{m}/\text{turn}$



NEW:







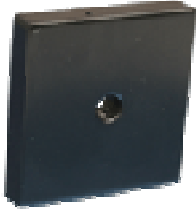
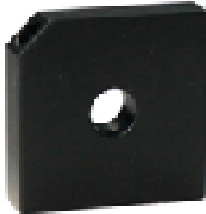
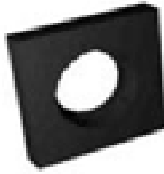

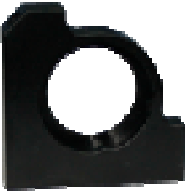

Bodies

		<p><i>Due to strong spring forces we offer the RD2-HS only with two alignment screws. If a third screw should be necessary we recommend the screw as hexagon socket for easier alignment</i></p>
RD2-HS-L2-30...	RD2-HS-R2-40...	

Frontplates

				
...3000/4000	...-3010/4010 (6H7)	...-3021/4021 (1/2")	...-3025/4025 (1")	...-3030/4030 (1")

				
3030z/4030z (1")	...-3000-25(1") ...-4000-25 (1")	...-3040/4040 (1,5") ...-3045/4045 (2")	...-3060/4060 (1")	...-3050/4050 (1,5") ...-3055/4055 (2")

			
...-3035Up/ ...4035Up	...-3035Down/ ...-4035Down	...-U(p) (1")	...-D(own) (1")

The order number of the desired RD2-HS mirror mount consists of the number of the body-plate including quantity of the screws and the number of the chosen front-plate.

RD-VO

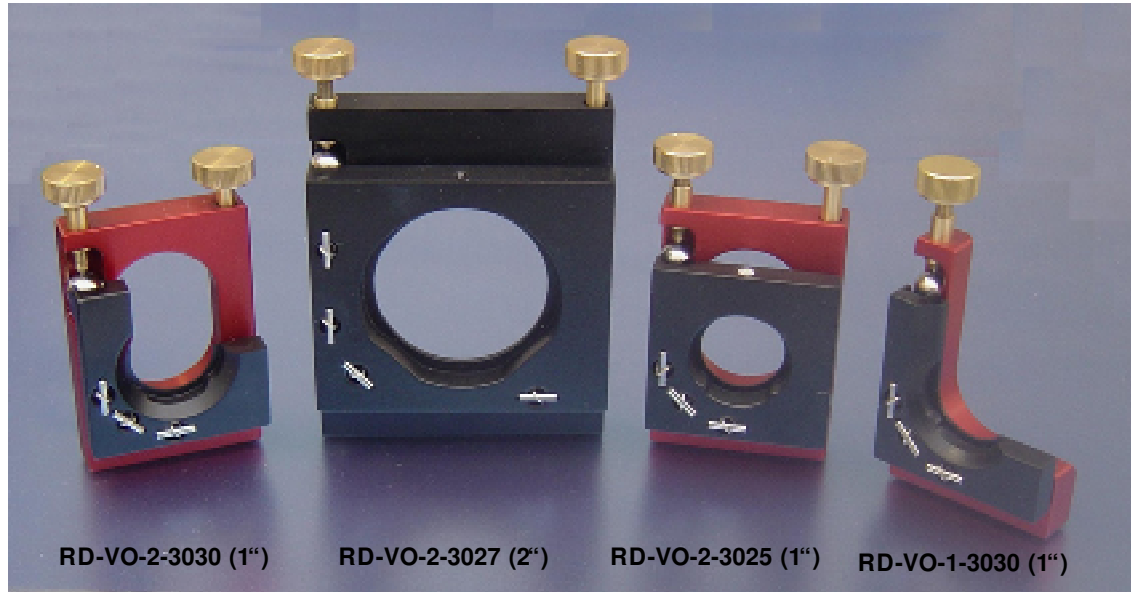

These mirror holders used from above allow a smooth and very precise adjustment without the danger to reach into the beam path. The translation of the rotary motion through a ball facilitate a resolution of 0.125 mm per turn.

Because of their robust construction the mirror holder can be built into resonators without any problems.

Available in the following versions :

- **RD-VO-1-...** One fine thread screw
- **RD-VO-2-...** Two fine thread screws
- For one or two inch optics
- Two different front plates



Gimbal Mirror Mounts

SK-FGS

Features:

- Gimbal Mount
- 2 brass screws with 0.25 mm pitch is standard
- Option: with 150 μm fine thread screws
- On request micrometer screws with 0.25 mm or 0.5 mm pitch or stainless steel fine thread screws are available.

SK- FGS-1

Cardanic mirror mount for 1" optics

SK-FGS-0.5

0,5" inserts for cardanic mirror mount



Beam Height Adjustment Unit VSHW

This system offers the possibility to adjust the beam height over a broad range and to turn the beam direction at the same time continuously around an angle of $90^\circ - 270^\circ$. It is possible to carry out a specific adaptation of the polarisation direction, because with a change of the angle a turn of the polarisation is combined.

The installation sheet consists of different scanning and fastening possibilities.

VSHW

includes:

- Two Mirror Mounts (you can chose between MDI or MDI-HS) with two fine thread screws and adapters
- Stainless Steel Pedestal (Standard length 200 mm , on request up to 300 mm)
- Holding Fork
- Option: with 150 μm fine thread screws
- On request stainless steel fine thread screws are available.

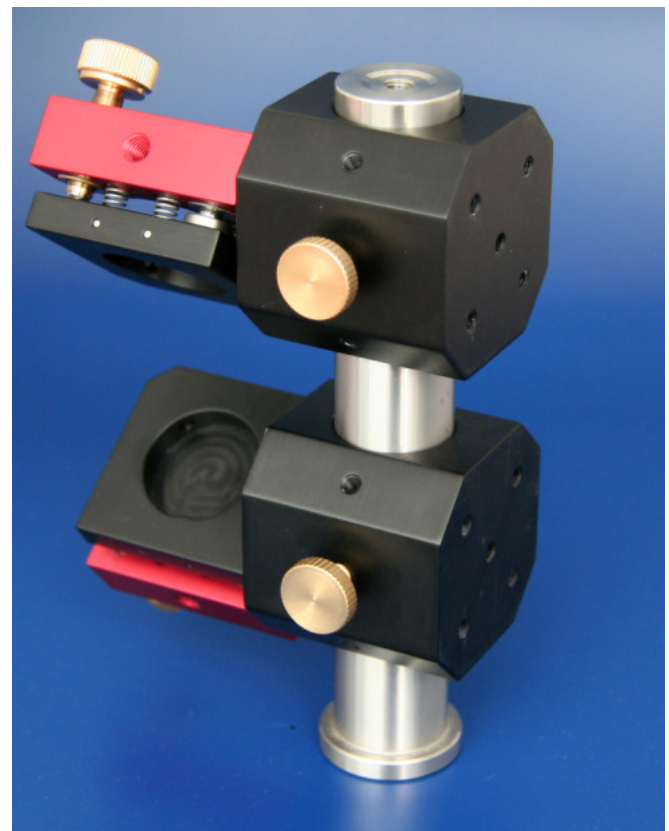

Mirror Mounts

Flip Mounts

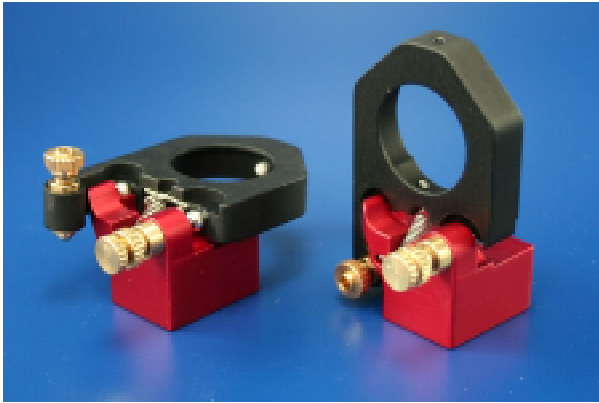

Our Flip Mount allows the user to flip an optic out of the beam path and back again without any re-alignment.

- With M4 thread

The Flip Mount is available in one and two inch (1" and 2").

Magnet Plates

The stable, repeatable and better option to flip mounts. 2 plates with 3 point bases fixed by a magnet.

RD-MP

- With M4 thread

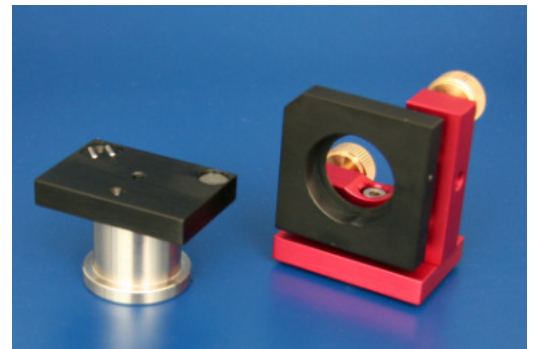
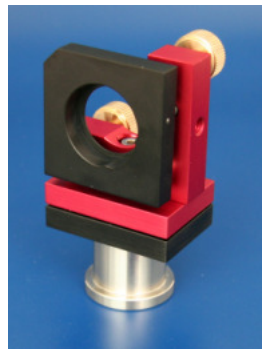

Magnet Plates for Prism Turn Tables

Repeatable, demountable option for Prism Turn Tables with magnets.

RD-MP-PDT-S for **RD-PDT-S**
RD-MP-PDT-B for **RD-PDT-B**

